

PRODUCT DATASHEET

FLOODLIGHT 180 W 4000 K IP65 BK

FLOODLIGHT 180 | Floodlight with symmetrical light output with 180 W



Areas of application

- Replacement for floodlights with halogen lamps
- Garages
- Public areas
- Building facades
- Construction areas
- D-sign according to EN 60598-2-24 for fire-risk commercial unit, f. e. by accumulation of dust

Product benefits

- Frosted cover made of tempered glass for uniform illumination
- Optimized weight and size due to compact design
- No upper light output ratio (ULOR 0%) when mounted at 0° tilt
- Energy savings of up to 90 % compared to halogen lamp floodlights
- 5 years guarantee

Product features

- Luminaire efficacy: up to 110 lm/W
- Symmetrical beam angle: 100° x 100°
- Mounting bracket for up to 180° tilting
- Type of protection: IP65
- Impact resistance: IK08
- Ambient temperature in operation: -20...+50 °C
- Connection via 1 m cable, wiring required



TECHNICAL DATA

Electrical data

Nominal wattage	180.00 W
Nominal voltage	220...240 V
Mains frequency	50...60 Hz
Nominal current	820 mA
Inrush current	68 A
Inrush current time T_{h50}	1000 μ s
Max. no. of lum. on circuit break. B16 A	10
Max. no. of lum. on circuit break. C10 A	8
Max. no. of lum. on circuit break. C16 A	13
Power factor λ	> 0.90
Total harmonic distortion	< 20 %
Protection class	I
Operating mode	Integrated LED driver

Photometrical data

Luminous flux	20000 lm
Luminous efficacy	110 lm/W
Color temperature	4000 K
Light color (designation)	Cool White
Color rendering index Ra	≥ 80
Standard deviation of color matching	≤ 5 sdc _m
Photobiological safety group acc. to EN62778	RG1
Photobiological safety group acc. to EN62471	RG0
Beam angle	100 ° x 100 °

0.5	1.16 1.20	E(0°) 32839 E(C90) 49.3° 4613 E(C0) 50.1° 4341
1.0	2.33 2.39	E(0°) 8210 E(C90) 49.3° 1153 E(C0) 50.1° 1085
1.5	3.49 3.59	E(0°) 3649 E(C90) 49.3° 513 E(C0) 50.1° 482
2.0	4.65 4.78	E(0°) 2052 E(C90) 49.3° 288 E(C0) 50.1° 271
2.5	5.81 5.98	E(0°) 1314 E(C90) 49.3° 185 E(C0) 50.1° 174
3.0	6.98 7.18	E(0°) 912 E(C90) 49.3° 128 E(C0) 50.1° 121
Distance [m]	Cone diameter [m]	Illuminance [lx]
— C0/C180 (Half beam angle [°]: 100.2°) — C90/C270 (Half beam angle [°]: 98.6°)		

LDC typ cone

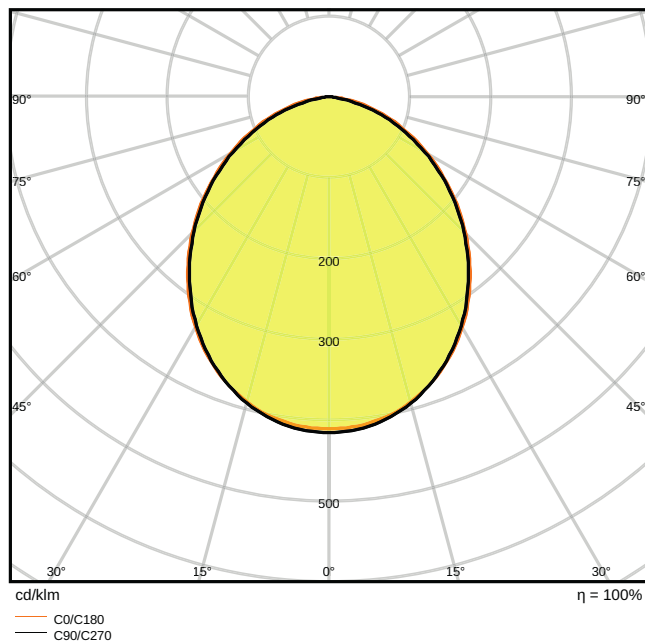

LDC typ polar

Dimensions & Weight

Length	340.00 mm
Width	310.00 mm
Height	81.00 mm
Product weight	4900.00 g
Cable length	1000 mm

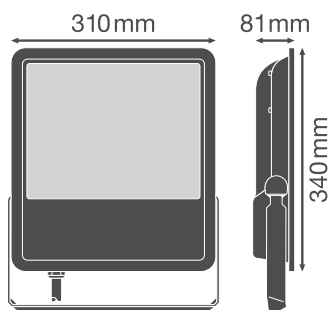

Materials & Colors

Product color	Black
Housing color	Black
Body material	Aluminum
Cover material	Tempered glass
Light emitting surface material	Glass
Glow Wire Test according to IEC 60695-2-12	650 °C
Mercury content	0.0 mg

Application & Mounting

Ambient temperature range	-20...+50 °C
Type of connection	Cable, 3-pole
Type of protection	IP65
Protection class IK (shock resistance)	IK08
Dimmable	No
Mounting type	Surface
Mounting location	Wall / Pole / Floor / Ceiling
Adjustable	Yes
LED module replaceable	Not replaceable

Lifespan

Lifespan L70/B50 at 25 °C	50000 h
Lifespan L80/B10 at 25 °C	30000 h
Lifespan L90/B10 at 25 °C	15000 h
Number of switching cycles	100000













Certificates & Standards

Standards	CE / CB / TÜV SÜD / EAC / RoHS
Luminaire with limited surface temperature, "D sign"	Yes
Ball shot safe	No

DOWNLOAD DATA

DOWNLOAD DATA	
	User instruction FLOODLIGHT 100DEG

DOWNLOAD DATA

	User instruction User Instruction Floodlight LED 100 DEG
	PRODUCT DATASHEET FLOODLIGHT LED 200 W 4000 K BK
	Tender documents Tender Text 4058075097728
	Certificates Floodlight 100 DEG CE Certificate
	Declarations of conformity EU Declaration of Conformity Floodlight 100DEG LEDV
	Declarations of conformity Attestation of Conformity Floodlight 100DEG TÜV
	On-Pack-Info Legal Insert Floodlight 100 DEG
	IES file (IES) Flood LED Sym 180W 4000K BK IP65
	LDT file (Eulumdat) Flood LED Sym 180W 4000K BK IP65
	R3D file (Relux 3D Model) Floodlight 180W
	M4D file (3D Model with rotation axis) Floodlight_180W
	ULD file (DIALux) FLOODLIGHT180180W4000KIP65BK
	UGR file (UGR table) Flood LED Sym 180W 4000K BK IP65

LOGISTICAL DATA

Product code	Packaging unit (Pieces/Unit)	Dimensions (length x width x height)	Gross weight	Volume
4058075097728	Shipping box 1	423 mm x 355 mm x 144 mm	5559.00 g	21.62 dm ³

The mentioned product code describes the smallest quantity unit which can be ordered. One shipping unit can contain one or more single products. When placing an order, for the quantity please enter single or multiples of a shipping unit.

ADDITIONAL CATALOG INFORMATION

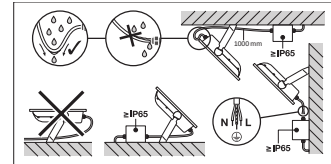
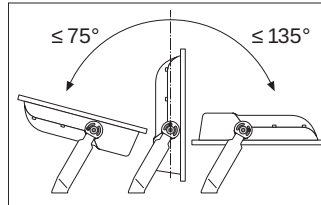
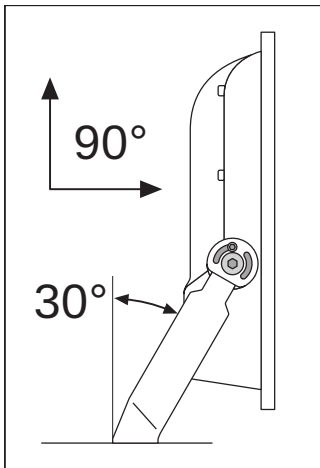

References / Links

– For Guarantee see www.ledvance.com/guarantee

DISCLAIMER

Subject to change without notice. Errors and omission excepted. Always make sure to use the most recent release.